

# specifications

## Hardigg 19" E.I.A. Rackmount Assembly Dimensions

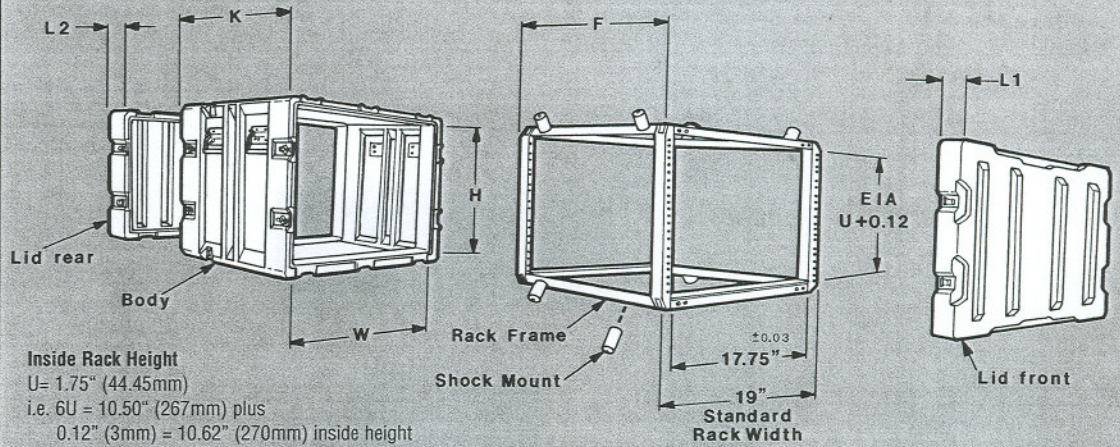

CASE SIZE PART NUMBER	U-SIZE INCHES MILLIMETERS	SHIPPING CUBE FT <sup>3</sup> /M <sup>3</sup>	SHIPPING NET WT LBS/KG
DE 21 21 - 02 / 18 / 02 reduced* sway space 05 / 18 / 05	10U 17.62" 448mm	8.9 / 0.25 9.8 / 0.28 10.8 / 0.30	47 / 21.3 49 / 22.2 51 / 23.1
DE 21 21 - 02 / 30 / 02 reduced* sway space 05 / 30 / 05	10U 17.62" 448mm	13.0 / 0.37 14.0 / 0.40 14.9 / 0.42	76 / 34.5 78 / 35.4 80 / 36.3
DE 24 12 - 02 / 24 / 02 05 / 24 / 02 05 / 24 / 05	4U 7.12" 181mm	7.9 / 0.22 8.6 / 0.24 9.3 / 0.26	50 / 22.7 51 / 23.1 52 / 23.6
DE 24 14 - 02 / 24 / 02 05 / 24 / 02 05 / 24 / 05	5U 8.87" 225mm	8.9 / 0.25 9.6 / 0.27 10.4 / 0.29	52 / 23.6 54 / 24.5 56 / 26.4
DE 24 14 - 02 / 27 / 02 05 / 27 / 02 05 / 27 / 05	5U 8.87" 225mm	9.7 / 0.27 10.5 / 0.30 11.3 / 0.32	53 / 24.0 55 / 25.0 57 / 25.9
DE 24 16 - 02 / 24 / 02 05 / 24 / 02 05 / 24 / 05	6U 10.62" 270mm	9.8 / 0.20 10.7 / 0.30 11.6 / 0.33	56 / 25.4 57 / 25.8 59 / 26.8
DE 24 16 - 02 / 27 / 02 05 / 27 / 02 05 / 27 / 05	6U 10.62" 270mm	10.8 / 0.31 11.6 / 0.33 12.5 / 0.35	57 / 25.9 59 / 26.8 60 / 27.2
DE 24 18 - 02 / 20 / 02 05 / 20 / 02 05 / 20 / 05	7U 12.37" 314mm	9.5 / 0.27 10.4 / 0.29 11.3 / 0.32	69 / 26.8 61 / 27.7 63 / 28.6
DE 24 18 - 02 / 27 / 02 05 / 27 / 02 05 / 27 / 05	7U 12.37" 314mm	11.8 / 0.34 12.8 / 0.36 13.8 / 0.39	60 / 27.2 62 / 28.1 64 / 29.0
DE 24 21 - 02 / 27 / 02 05 / 27 / 02 05 / 27 / 05	9U 15.87" 403mm	13.5 / 0.38 14.6 / 0.41 15.6 / 0.44	70 / 31.8 71 / 32.2 73 / 33.1
DE 24 25 - 02 / 27 / 02 05 / 27 / 02 05 / 27 / 05	11U 19.36" 492mm	16.6 / 0.44 16.9 / 0.48 18.1 / 0.51	75 / 34.0 78 / 35.4 81 / 36.7
DE 24 30 - 02 / 27 / 02 05 / 27 / 02 05 / 27 / 05	14U 24.62" 625mm	18.3 / 0.52 19.8 / 0.58 21.3 / 0.60	79 / 35.8 81 / 36.7 83 / 37.6
DE 24 42 - 02 / 27 / 02 05 / 27 / 02 05 / 27 / 05	21U 36.87" 936mm	24.8 / 0.70 26.8 / 0.76 28.8 / 0.81	103 / 46.7 105 / 47.6 107 / 48.5
DE 26 52 - 02 / 25 / 02 05 / 25 / 02 05 / 25 / 05	26U 45.62" 1159mm	30.5 / 0.86 33.1 / 0.94 35.7 / 1.01	119 / 53.9 121 / 54.9 123 / 55.8

### EXAMPLE: CASE SIZE NUMBER

DE 24 12 - 02 / 24 / 05

Please note all  
dimensions are nominal.

L2 = Lid (rear) Interior Depth (2.5 or 5.25" /  
63 or 127mm) (Rear) (for exterior dim.  
add 1.25" / 32mm)

K = Case Body Interior Depth (24" / 610mm)  
(for exterior dim. add 0")

L1 = Lid (front) Interior Depth (2.5 or 5.25" / 63 or 127mm)  
(Front) (for exterior dim. add 1.25" / 32mm)

H = Case Body Interior Height (12" / 305mm)  
(for exterior dim. add 3" / 76mm)

W = Case Body Interior Width (24" / 610mm)  
(for exterior dim. add 3" / 76mm)

Double Lid (End/Entry)

i.e. when K is 27" then F is 25"  
i.e. when K is 686mm then F is 635mm

Case Body Length	K	18"	20"	24"	25"	27"	30"
		457mm	508mm	610mm	635mm	686mm	762mm
Rack Length	F	17"	18"	20"	23"	25"	28"
		431mm	457mm	508mm	584mm	635mm	711mm

### STANDARD RACKFRAME LOAD RANGES

SHOCKMOUNTS PER SYSTEMS	LOAD RANGES (lbs/kg) FOR EQUIPMENT INSTALLED IN RACK
8 ea	20 to 40 lbs / 9.1 to 18.1 kg
8 ea	40 to 60 lbs / 18.1 to 27.2 kg
8 ea	60 to 80 lbs / 27.2 to 36.3 kg
8 ea	80 to 100 lbs / 36.3 to 45.4 kg
8 ea	100 to 170 lbs / 45.4 to 77.1 kg
16 ea	160 to 200 lbs / 72.6 to 90.7 kg
16 ea	Δ 200 to 340 lbs / 90.7 to 154.2 kg

\* Special shock mounts required for reduced sway space.  
 Δ For weights over 340 lbs call for assistance.

Your Local Authorized Dealer



Women Owned  
Small Business

Technical Sales & Applications, Inc. - DARIA BOLEY  
 185 S. CENTRAL AVE. • OVIEDO, FL 32765  
 PHONE (407) 365-2233 • FAX (407) 365-8422  
 dboleym@tsafl.com • www.tsafl.com

# Accessories

The Hardigg 19" Versa-Rack internal frame may be customized by adding either vertical and/or horizontal bracing. Hardigg specializes in many other custom applications for 19" Rackmount Cases. The standard case color is grey. Optional colors are olive drab, dark blue, purple, forest green, tan, yellow, white, orange, maroon, black, red and light blue. Please call for more information on the wide range of accessories for Hardigg Cases.

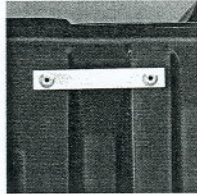

## Lid Hanger

Stores lid on side of case when case is open.



## Pressure Relief Valve

Available on all Hardigg cases. Includes all gasketing required to safely maintain controlled pressure differential.

## Keyboard Tray

Attaches to front of case. 24" x 12", folds flat for storage.

## Blank Bezel Plate

16-gauge aluminum. Flanged for strength. Available in 1U, 2U, 3U and 4-Unit heights (1U = 1.75").

## Enclosed Storage Drawer with Slides and Keylock

Drawers are 14" deep (front to back) and available in 2U, 3U and 4-Unit heights (1U = 1.75").

## Rack Slides

Mil-spec, compact, solid bearing slides. Equipment drawers or shelves can be mounted directly to slides.

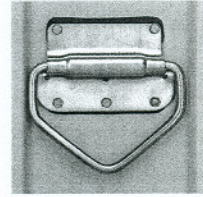
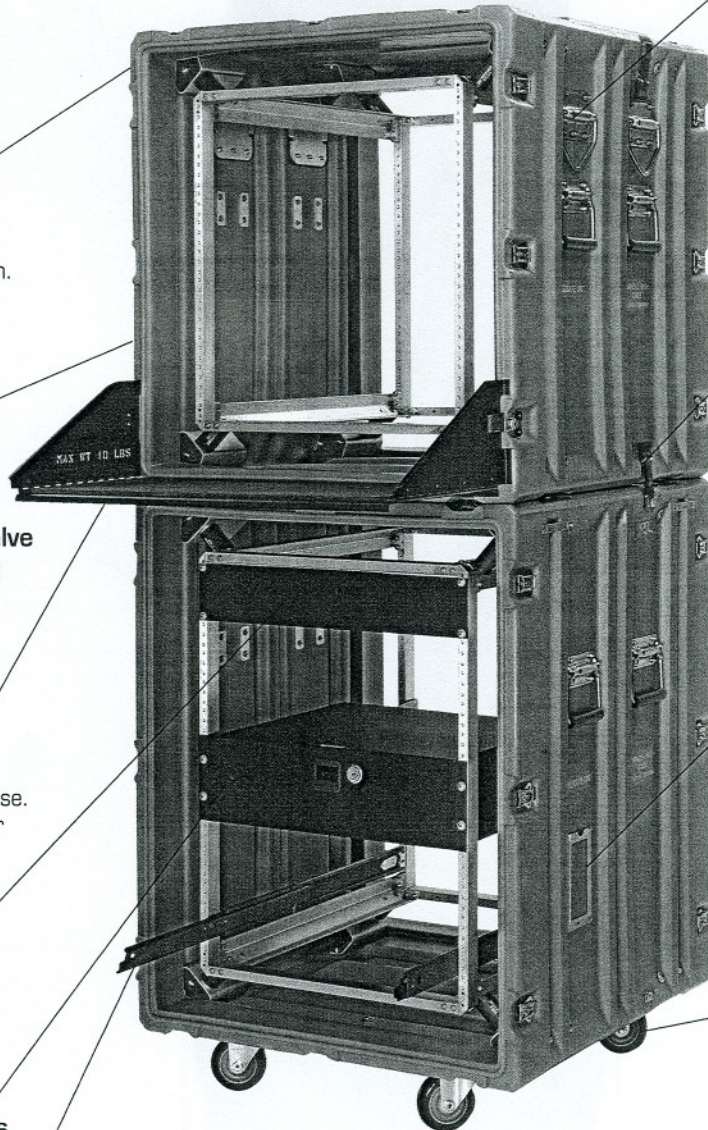

## Lifting Rings

Bolt-mounted with backup plates for hoisting or tie-down of case. Rated at 500 lbs. pull strength per ring.

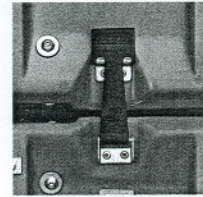

## Coupling Catches

Positive locking system for vertical stacking of rackmount enclosures.

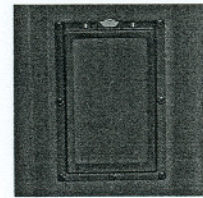

## Shipping Card Holder

Metal frame riveted to case in prominent location. Two sizes (3" x 5" or 4" x 6").

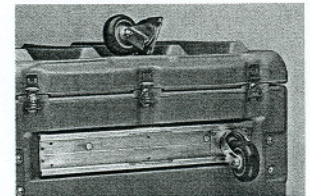

## Heavy-duty Fixed and Removable Casters

Removable or fixed, recessed caster holder design. Triple ball bearing action. Mounted on load-spreading base system for maximum container weight support. Two wheel sizes (2.5" or 3.5").

## Stainless Steel Hardware

Catches, strikes, handles, lift rings, all available in stainless steel.

## Identification Plate

Riveted to container. Meets MIL- P-15024 Type H.

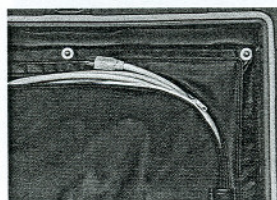

## Storage Pouch

Zippered pouch for storing cables and accessories in front or rear lids.